

AMERICAN ELITE STRATOCASTER® (011400XXXX)

PARTS LAYOUT

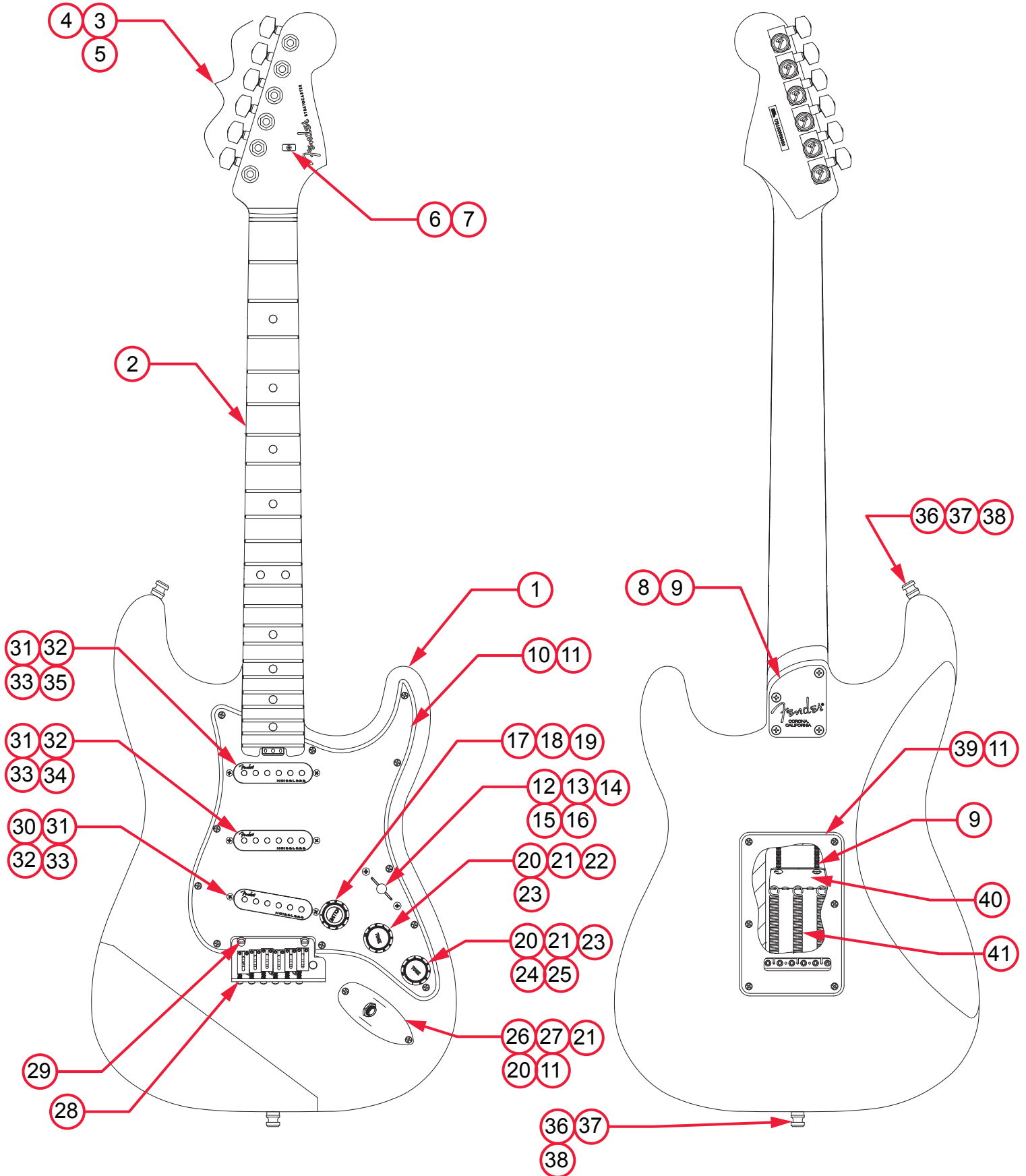

AMERICAN ELITE STRATOCASTER® (011400XXX)

PARTS LIST

REF#	DESCRIPTION	PART NUMBER
1	BODY AM ELITE STRAT 3TSB	7708470500
1	BODY AM ELITE STRAT BLK	7708471510
1	BODY AM ELITE STRAT OLP	7708471523
1	BODY AM ELITE STRAT ACB	7708472531
1	BODY AM ELITE STRAT SBM	7708471536
1	BODY AM ELITE STRAT TBS	7708472552
1	BODY AM ELITE STRAT ABM	7708471596
2	NECK ASSY AM ELITE STRAT MAPLE	7708464000
2	NECK ASSY AM ELITE STRAT ROSEWOOD	7708465000
3	KEY LOCKING 1,2,3 POLISHED CHROME EA	0073114000
4	BUSHING KEY SET	0058820049
5	WASHER KEY SET	0053106049
6	STRING TREE AM ELITE GUITAR CHROME	7708381000
7	SCREW SMA 2 X 9/16 FHP NICKEL	0051621000
8	NECK PLATE GUITAR DELUXE CHROME ALUM RH NO HOLE	7708496000
9	SCREW SMA 8 X 1-3/4 OHP NICKEL	0015636049
10	PICKGUARD AM ELITE STRAT SSS MG/BLK/MG	7708282000
10	PICKGUARD AM ELITE STRAT SSS BROWN SHELL	7708281000
11	SCREW SMAB 4 X 1/2 ONP NICKEL	0015578049
12	5-WAY SWITCH LEVER DISCRETE/COM	0078776000
13	SWITCH KNOB VINTAGE AGED WHITE	0994938000
14	SCREW M 6-32 X 5/8 RHP NICKEL	0015800049
15	CAPACITOR CD .01µF 600V 10% 1/2" DIAMETER	0054504049
16	RESISTOR 1/4W 470KΩ	0066911000
17	KNOB STRAT VOLUME S-1 SOFT OVERMOLD AGED WHITE	7708070000
18	SWITCH CAP S-1 STRAT AGED WHITE VOLUME	0059266030
19	SWITCH/POT S-1 250K .25 BUSHING W/NUT & WASHER	0078777000
20	WASHER LOCKING INTL 3/8 X .687 X .065 NICKEL	0016436049
21	NUT HEX 3/8-32 X 3/32 NICKEL	0016352049
22	CONTROL 250K 10% TAPER	0078779000
23	KNOB STRAT TONE SOFT OVERMOLD AGED WHITE	7708072000
24	CONTROL 250K 10% TAPER NO-LOAD	0078780000
25	CAPACITOR MPF RDL .022µF 250V 10%	0024832000
26	FERRULE JACK CHROME	0991940000
27	JACK PHONE OPEN CIRCUIT 11	0021956049

*= NOT PICTURED IN DIAGRAM



AMERICAN ELITE STRATOCASTER® (011400XXX)

REF#	DESCRIPTION	PART NUMBER
28	BRIDGE ASSY STRAT AM DLX RH	0077092000
28A	BRIDGE PLATE ULTRA STRAT	0036527000
28B	BLOCK TREMOLO AM DLX STRAT RH	0077090000
28C	BRIDGE SECTION ULTRA STRAT	0990840100
28D	SPRING BRIDGE 4 COIL 3/8 BLACK	0019394049
28E	SPRING-BRIDGE 3 COIL 1/4 BLACK	0019395049
28F	SCREW M 4-40x5/8 PHP BLK	0017031049
28G	SCREW HEIGHT ADJ. 1/4	0026779049
28H	SCREW HEIGHT ADJ. 5/16	0026780049
28I	SCREW M 8-32x3/8 FHP NI	0019656049
28J	SPRING CLIP, ULTRA	0036531000
28K	BUSHING NYL BLK .31OD .22ID x .87L	0036614000
28L	SCRW SET 10-32x3/16 HEX SKT FP BLXL	0036615049
29	PIVOT POST ASSY	0093273000
30	PICKUP ASSY STRAT DELUXE NOISELESS AGED WHITE BRIDGE	7708558000
31	COVER PICKUP STRAT DELUXE NOISELESS AGED WHITE	7708561030
32	SCREW SPECIAL M 4-40 X 13/16 #5 HEAD NICKEL	0099474000
33	TUBING SILICONE RUBBER CUT RED .500	0063398000
34	PICKUP ASSY STRAT DELUXE NOISELESS AGED WHITE MIDDLE	7708557000
35	PICKUP ASSY STRAT DELUXE NOISELESS AGED WHITE NECK	7708428000
36	STRAP BUTTON CHROME SET W/HDWR	0990690000
37	SCREW SMAB 5 X 1 OHP NICKEL	0015610049
38	FELT WASHERS BLACK V	0994929000
38	FELT WASHERS WHITE	0994930000
39	BACK COVER STRAT STD W/SLOT BROWN SHELL	0991324000
39	BACK COVER STRAT STD W/SLOT MG/BLK/MG	0054029000
40	SPRING CLAW TENSION NICKEL	0010272100
41	SPRING TREMOLO TENSION BLK	0018671049
*	CASE MOLDED AM ELITE GUITAR	7708547000
*	TREMOLO ARM ULTRA DLX SNAPIN	0036534049
*	WRENCH .050 HEX KEY SHORT ARM	0018531049
*	WRENCH 3/32 HEX KEY SHORT ARM	0018622000

*= NOT PICTURED IN DIAGRAM



AMERICAN ELITE STRATOCASTER® (011400XXXX)

PICKUP WIRING

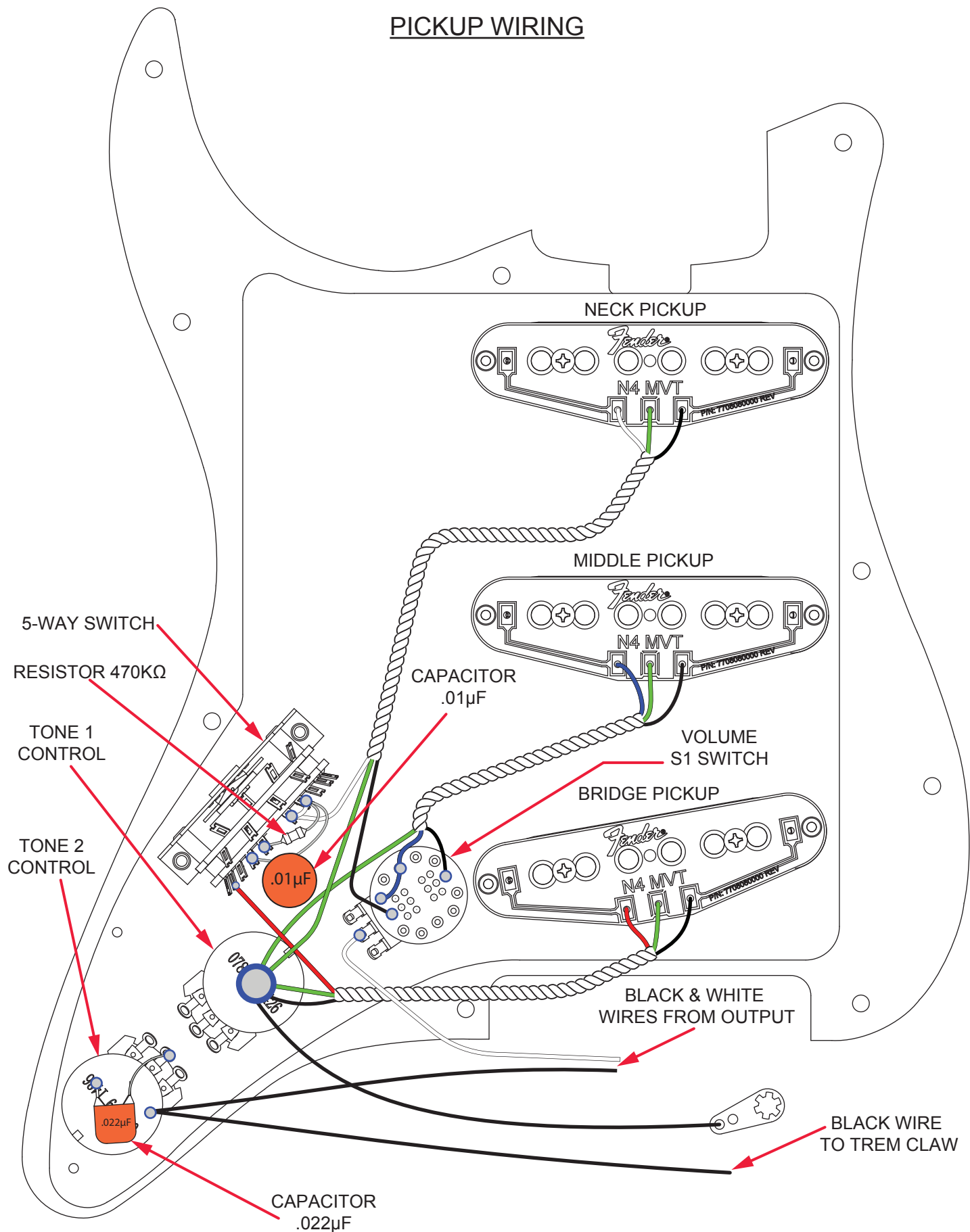

AMERICAN ELITE STRATOCASTER® (011400XXXX)

DETAILED WIRING DIAGRAM

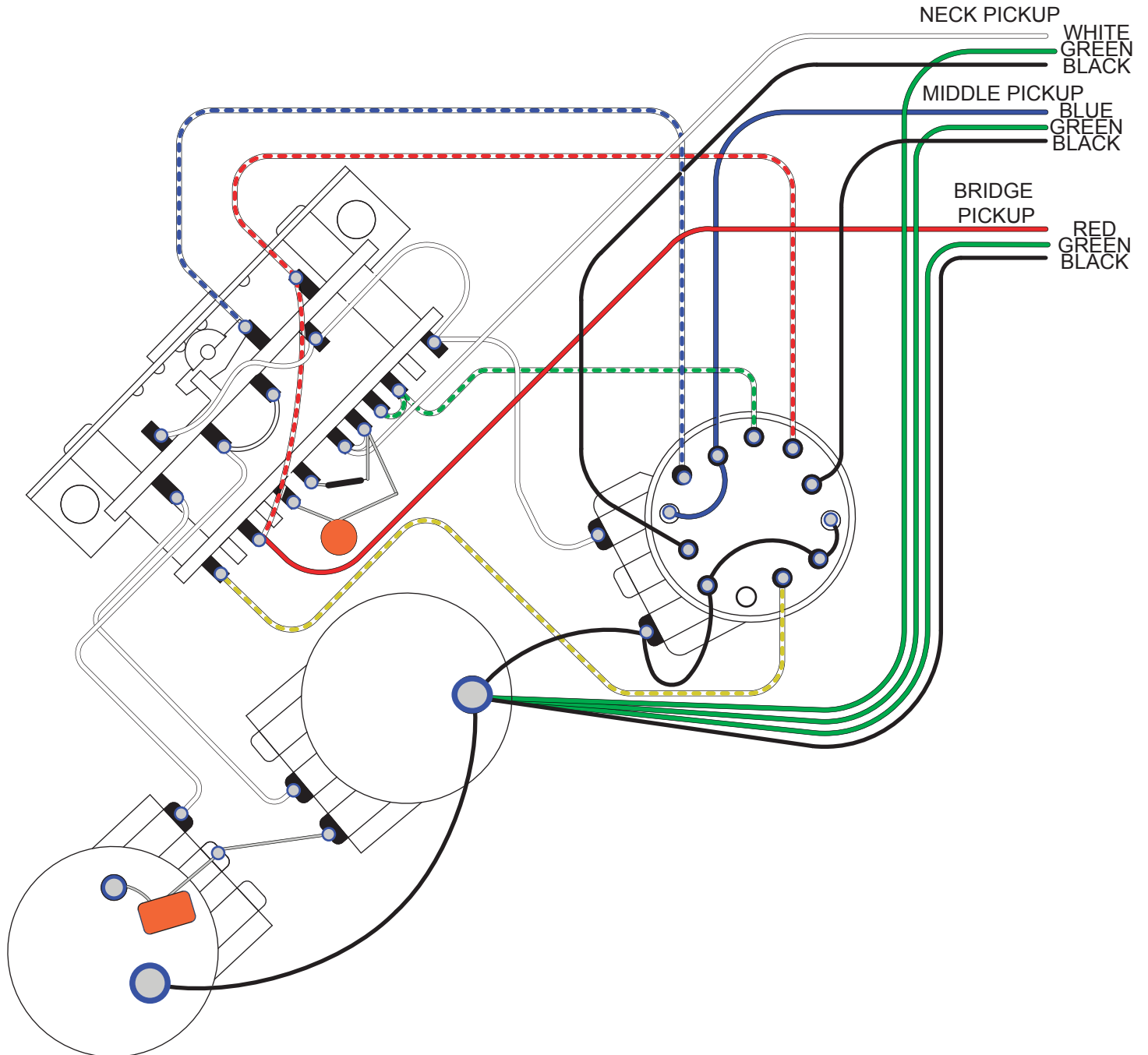

AMERICAN ELITE STRATOCASTER® (011400XXXX)

SWITCH AND CONTROL FUNCTION

T1 ONLY	T1 & T2	T2 ONLY	T2 ONLY	T2 ONLY	TONE CONTROL	
					5 WAY SELECTOR POSITION	 S-1 SWITCH OFF (UP POSITION)
					NECK PU (A)	COMBINED PICKUPS ARE IN PARALLEL
					MIDDLE PU (B)	
					BRIDGE PU (C)	
					5 WAY SELECTOR POSITION	 S-1 SWITCH ON (DOWN POSITION)
					NECK PU (A)	COMBINED PICKUPS ARE IN SERIES AS SHOWN
					MIDDLE PU (B)	
					BRIDGE PU (C)	
						ADDITIONAL COMMENT

PICKUP IS ON PICKUP IS OFF
 DIMINISHED VOLUME

BRIDGE PICKUP IN PARALLEL WITH NECK & MIDDLE PICKUPS IN SERIES.
 NECK PICKUP IN PARALLEL WITH MIDDLE & BRIDGE PICKUPS IN SERIES.

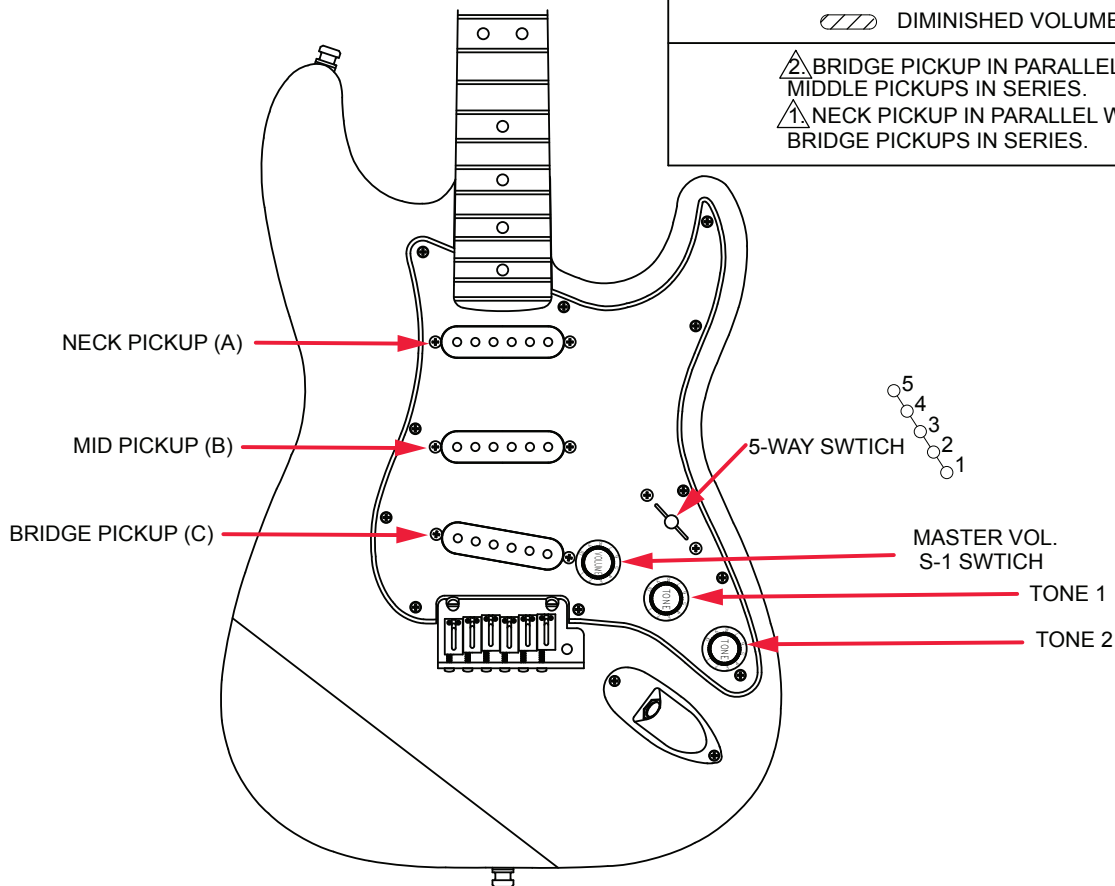

AMERICAN ELITE STRATOCASTER® (011400XXXX)

ADDITIONAL SPECIFICATION DETAIL

FRET SIZE: MEDIUM JUMBO
(FRET DIMENSIONS ARE BEFORE INSTALLATION)

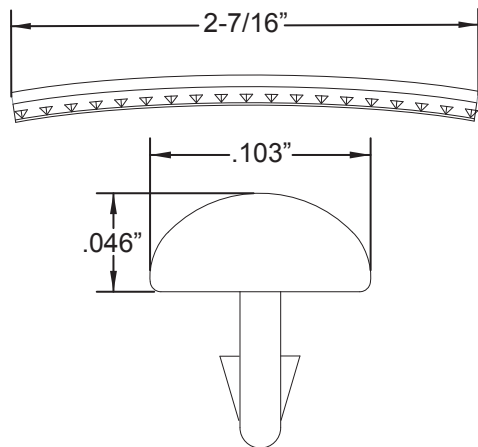

PLEASE NOTE: AS EACH NECK IS SANDED & FINISHED BY HAND, THICKNESS DIMENSIONS MAY VARY SLIGHTLY FROM THOSE SHOWN.

NECK PROFILE: COMPOUND "C" TO "D"

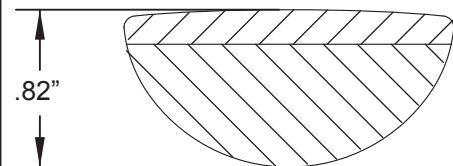

1ST FRET PROFILE

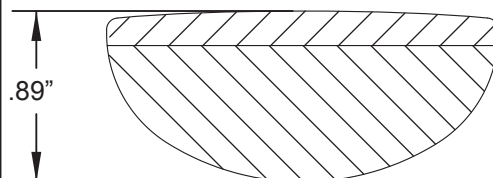

12TH FRET PROFILE

STAGGERED LOCKING TUNING MACHINES EA: P/N 0073114000
OUTER SHAFT DIAMETER .394"

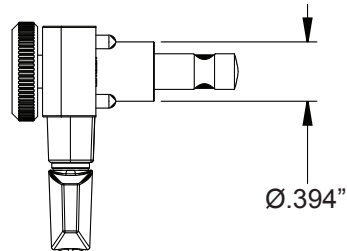

TUNING MACHINE THRU-HOLE
INNER DIAMETER .404"

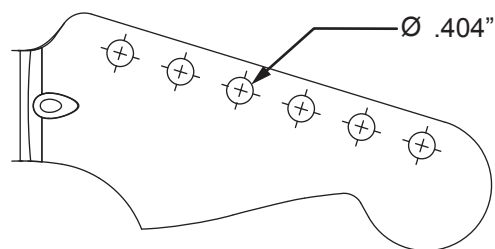

SADDLE HEIGHT ADJUSTMENT WRENCH:
.050" HEX KEY P/N 0018531049

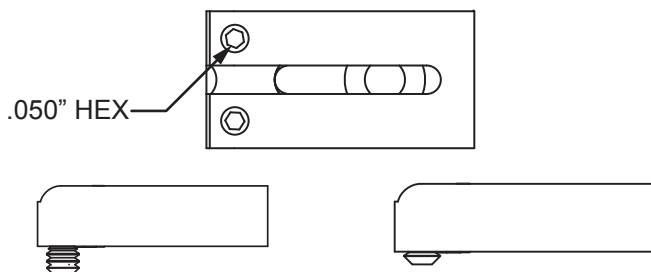

SADDLE HEIGHT ADJUSTMENT SCREWS:
TALL: P/N 0031913049 SHORT: P/N 0017031049

TRUSS ROD THUMB WHEEL:
P/N 7708832000 GOLD - P/N 7708809000 BLACK
TRUSS ROD ADJUSTMENT WRENCH:
3/32" HEX KEY P/N 0018622000

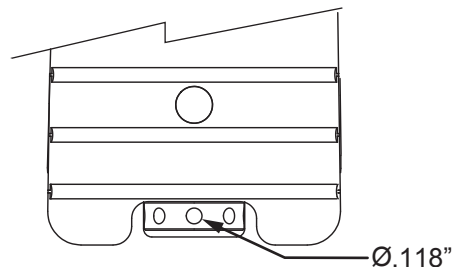

LOGO: AM ELITE STRAT DECAL BLACK CHROME
APPLIED UNDER THE FINISH



PICKUP SPECIFICATIONS

POSITION	MAGNETS	DC RESISTANCE	POLARITY
NECK	ALNICO 5 UNBEVELED	10.0 - 10.6KΩ	NORTH
MIDDLE	ALNICO 5 UNBEVELED	10.0 - 10.6KΩ	NORTH
BRIDGE	ALNICO 5 UNBEVELED	10.0 - 10.6KΩ	NORTH